

DCL SERIES

Die Cast Sports Fixtures



OPTICS

The Die Cast Sports Luminaire is designed to produce a far reaching Forward Throw light pattern and is well suited for tennis court lighting no matter what the level of competition is. Limited back light and spillage makes this fixture efficient, precise, and keeps the light on the court where it belongs.

ACCESSORIES

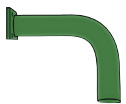

SINGLE DAVIT ARM
DV190



QUAD DAVIT ARM AT 70°
DV470



DOUBLE DAVIT ARM AT 90°
DV270



QUAD DAVIT ARM AT 90°
DV490



DOUBLE DAVIT ARM AT 180°
DV2180

PHOTOMETRICS

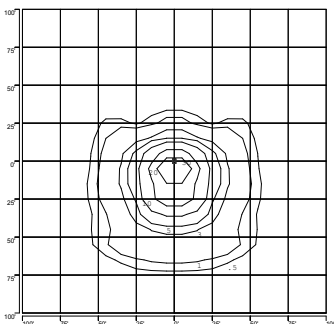

ISOFOOTCANDLE PLOT:
DCLB3GP1 1000W MH CENTER COURT SERIES
23' AFG - 0 DEGREE TILT

1.800.225.0727

ORDERING INFORMATION

1000W MH MT

DCLB3GP1- (A)

1000W MH 480V

DCLB3GP2- (A)

(A) Finish

BK - Black
BZ - Bronze
USG - US Green
WH - White
SP - Special

(All fixtures are pre-tapped at 240V from factory unless otherwise requested)

SHIELDS

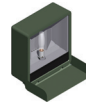

LARGE BACK SIDE SHIELD
S111

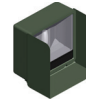

LARGE 3 SIDED BACK SIDE SHIELD
S114

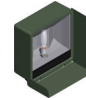

LARGE 2 SIDED BACK SIDE SHIELD
S120¹

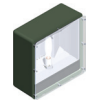

LARGE VANDAL SHIELD
S102

TECHNICAL INFORMATION

Constructed from a durable die cast aluminum housing with a faceted reflector and tempered glass lens. Comes standard with a 4KV pulse rated mogul base socket. Standard mounting options include davit and 7 degree rise arms. The fixture is finished with a durable polyester powdercoat paint.

EPA RATINGS

22" Housing 0° Tilt EPA: 1.64

Notes: 1-S120 Shield must be specified as a left or right sided shield from the mounting side point of view.

WWW.TEHLIGHTUSA.COM

DCL SERIES

Extruded Sports Fixtures

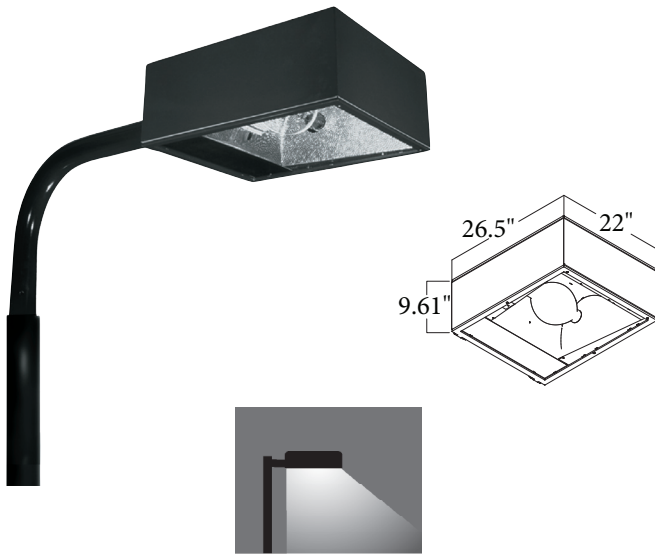

OPTICS

The Extruded Sports Luminaire is designed to produce a far reaching Forward Throw light pattern with the classic look Techlight has been producing for the tennis industry for years. It is well suited for tennis court lighting no matter the level of competition. Limited back this fixture efficient, precise, and keeps the light on the court where it belongs.

ACCESSORIES

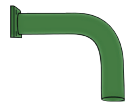

SINGLE DAVIT
ARM
DV190



QUAD DAVIT
ARM AT 70°
DV470



DOUBLE DAVIT
ARM AT 90°
DV270



QUAD DAVIT
ARM AT 90°
DV490



DOUBLE DAVIT
ARM AT 180°
DV2180

PHOTOMETRICS

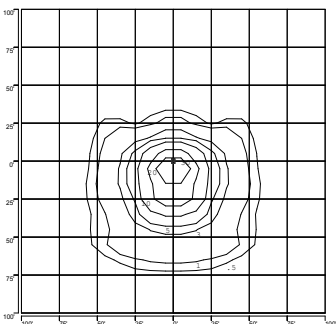

ISOFOOTCANDLE PLOT:
DCLB2GP1 1000W MH CENTER COURT SERIES
23' AFG - 0 DEGREE TILT

ORDERING INFORMATION

1000W MH MT

DCLB2GP1- (A)

1000W MH 480V

DCLB2GP2- (A)

(A) Finish

BK - Black
BZ - Bronze
USG - US Green
WH - White
SP - Special

(All fixtures are
pre-tapped at 240V
from factory unless
otherwise requested)

SHIELDS

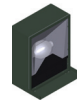

LARGE BACK SIDE
SHIELD
S83

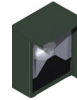

LARGE 3 SIDED FRONT
MOUNT SHIELD
S92

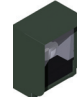

LARGE 2 SIDED FRONT
SIDE SHIELD
S132¹

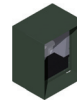

LARGE VANDAL SHIELD
S140

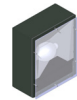

LARGE 4 SIDED SHIELD
S141

TECHNICAL INFORMATION

Constructed from an extruded aluminum housing with a faceted reflector and tempered glass lens. Comes standard with a 4KV pulse rated mogul base socket. Standard mounting options include davit and 7 degree rise arms. The fixture is finished with a durable polyester powdercoat paint.

EPA RATINGS

26.5" Housing 0° Tilt EPA: 3.0

Notes: 1-S132 Shield must be specified as a left or right sided shield from the mounting side point of view.

CENTER COURT PRO SERIES

Vertical Burn Sport Fixtures

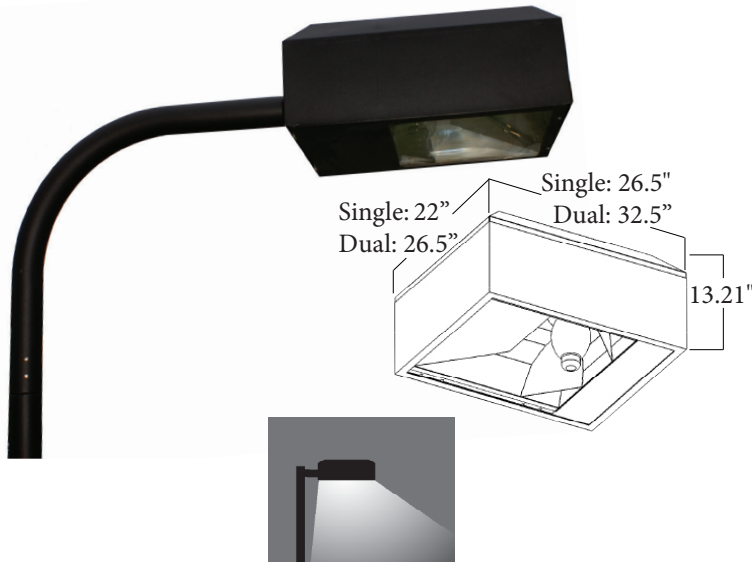

ORDERING INFORMATION

Single Lamp

775W PSMH MT	LSBVG6A1-PS-(A)
1000W MH MT	LSBVG1A1-(A)
1000W PSMH MT	LSBVG1A1-PS-(A)

Dual Lamp

775W DUAL PSMH MT	LSBVG6A2-PS-(A)
1000W DUAL MH MT	LSBVG1A2-(A)
1000W DUAL PSMH MT	LSBVG1A2-PS-(A)

(A) Finish

- BK - Black
- BZ - Bronze
- USG - US Green
- WH - White
- SP - Special

(All fixtures are pre-tapped at 240V from factory unless otherwise requested)

OPTICS

The Center Court Pro Series Luminaire is designed as a superior lighting solution for tennis courts by utilizing the most efficient technology available. It provides exceptionally higher light levels for less wattage. The quality of construction and ease of installation not only makes it the first choice in tennis lighting, but the only choice for many industry professionals.

ACCESSORIES

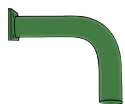

SINGLE DAVIT ARM DV190



QUAD DAVIT ARM AT 70° DV470



DOUBLE DAVIT ARM AT 90° DV270

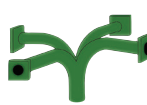

QUAD DAVIT ARM AT 90° DV490



DOUBLE DAVIT ARM AT 180° DV2180

PHOTOMETRICS

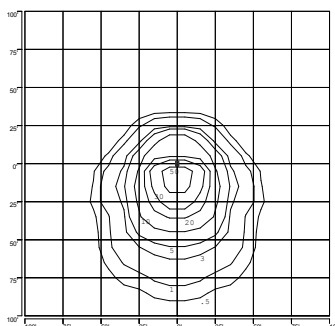

ISOFOOTCANDLE PLOT:
LSBVG1A1 1000W MH VB CENTER COURT
23' AFG - 0 DEGREE TILT

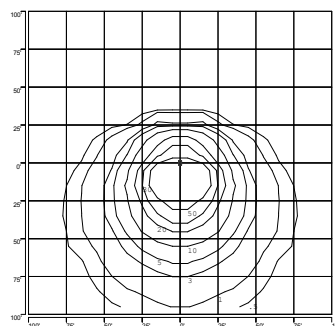

ISOFOOTCANDLE PLOT:
LSBVG1A2 DUAL 1000W MH VB CENTER COURT
23' AFG - 0 DEGREE TILT

TECHNICAL INFORMATION

Constructed of durable formed aluminum. State of the art Enhanced High Performance specular reflector. High transmission glass technology. Vertical lamp orientation and 4KV pulse rated mogul base socket. Available in single and dual lamp versions. Standard mounting options include davit and 7 degree rise arms. The fixture is finished with a durable polyester powdercoat paint.

EPA RATINGS

Single Housing 0° Tilt EPA: 2.5
Dual Housing 0° Tilt EPA: 3.0

SPORTLIGHTER SERIES

Sports Lighting Fixtures

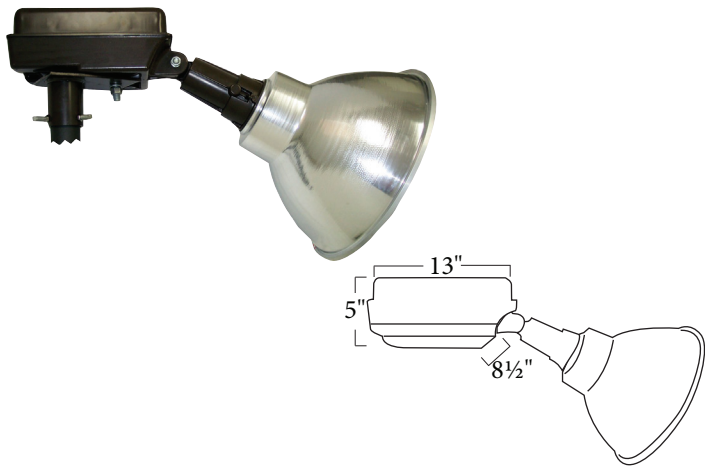

OPTICS

The Sportlighter is the "go to" high wattage HID fixture for large ball field lighting or specialized applications where a lot of punch is needed. The wide range of beam patterns allows it to be used as a wide flood covering a large ball field or a narrow spot on a target at a shooting range.

ACCESSORIES

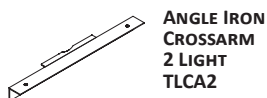

ANGLE IRON
CROSSARM
2 LIGHT
TLCA2



ANGLE IRON
CROSSARM
3 LIGHT
TLCA3

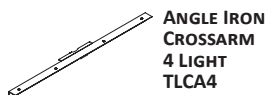

ANGLE IRON
CROSSARM
4 LIGHT
TLCA4



ANGLE IRON
CROSSARM
5 LIGHT
TLCA5



2-3/8" OD
TENON TOP
FITTER
SP50PT



WOOD POLE
MOUNT BRACKET
WWPIM

PHOTOMETRICS

IES FLOOD REPORT
PHOTOMETRIC FILENAME: SL51000MH_3.IES
AXIAL CANDELA DISPLAY

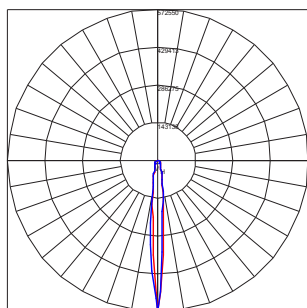

Maximum Candela = 97250 Located At Horizontal Angle = 0, Vertical Angle = 0
H - Horizontal Axial Candela
V - Vertical Axial Candela

IES FLOOD REPORT
PHOTOMETRIC FILENAME: SL51000MH_4.IES
AXIAL CANDELA DISPLAY

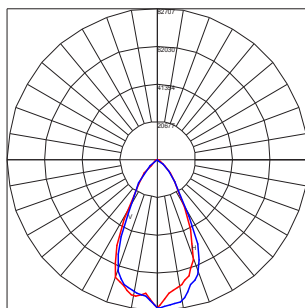

Maximum Candela = 82707 Located At Horizontal Angle = 5, Vertical Angle = 0
H - Horizontal Axial Candela
V - Vertical Axial Candela

ORDERING INFORMATION

1000W MH MT NEMA 2	SPORTLIGHTER-1-3-3-0-0-(A)
1000W MH MT NEMA 3	SPORTLIGHTER-2-3-3-0-0-(A)
1000W MH MT NEMA 4	SPORTLIGHTER-3-3-3-0-0-(A)
1000W MH MT NEMA 5	SPORTLIGHTER-4-3-3-0-0-(A)
1000W MH MT NEMA 6	SPORTLIGHTER-5-3-3-0-0-(A)
1500W MH MT NEMA 2	SPORTLIGHTER-1-5-5-0-0-(A)
1500W MH MT NEMA 3	SPORTLIGHTER-2-5-5-0-0-(A)
1500W MH MT NEMA 4	SPORTLIGHTER-3-5-5-0-0-(A)
1500W MH MT NEMA 5	SPORTLIGHTER-4-5-5-0-0-(A)
1500W MH MT NEMA 6	SPORTLIGHTER-5-5-5-0-0-(A)

(A) Finish

BK - Black
BZ - Bronze
USG - US Green
WH - White
SP - Special

SHIELDS



VISOR SHIELD FOR
NEMA 4, 5, 6
S144

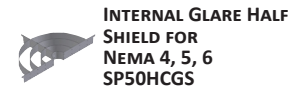

INTERNAL GLARE HALF
SHIELD FOR
NEMA 4, 5, 6
SP50HCGS



VISOR SHIELD FOR
NEMA 2
S167



VISOR SHIELD FOR
NEMA 3
S168



INTERNAL GLARE
SHIELD FOR
NEMA 4, 5, 6
SP50CGS



INTERNAL GLARE
SHIELD FOR NEMA 3
SP50CGS23

TECHNICAL INFORMATION

Constructed from an die cast aluminum housing. Spun anodized aluminum reflector available in Type 2, 3, 4, 5, and 6. Tempered flat glass lens and gasket with aluminum clamp band. Comes standard with angle iron through bolt. Provided with a multi-tap or 480V CWA ballast. The ballast housing is finished with a durable polyester powdercoat paint.

EPA RATINGS

Nema 2 thru 6 EPA 2.0

ICF SERIES

Indirect Sports Fixtures

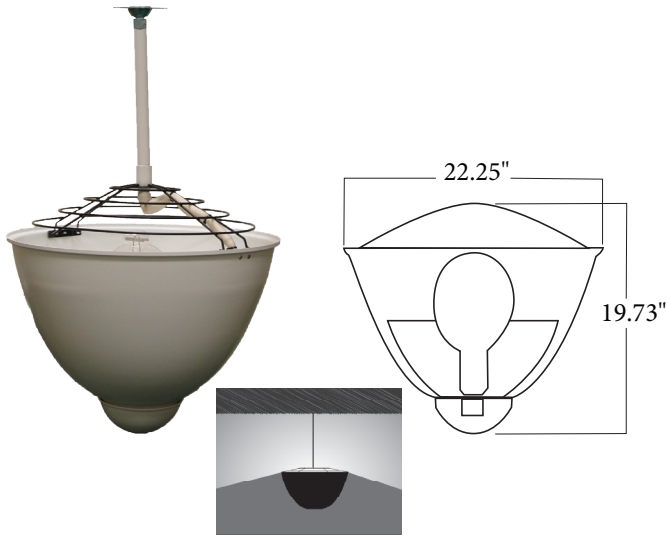

ORDERING INFORMATION

1000W MH 5-TAP

ICF1000-5

(A) Finish

- BK - Black
- BZ - Bronze
- USG - US Green
- WH - White
- SP - Special

OPTICS

The ICF fixture is a combination of rugged design with state of the art lighting concepts. Designed for use in indoor sports applications, the ICF can deal with errant tennis balls or worse. The indirect lighting design provides glare free light for the least amount of distraction or nuisance and the best indoor sporting experience possible.

PHOTOMETRICS

IES INDOOR REPORT
PHOTOMETRIC FILENAME : BAL12382.IES
POLAR GRAPH

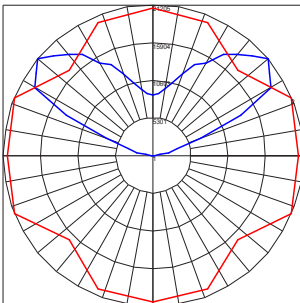

Maximum Candela = 21,205 Located At Horizontal Angle = 22.5, Vertical Angle = 130
1 - Vertical Plane Through Horizontal Angles (22.5, -202.5) (Through Max. Cd.)
2 - Horizontal Cone Through Vertical Angle (130) (Through Max. Cd.)

1.800.225.0727

WWW.TEHLIGHTUSA.COM

TECHNICAL INFORMATION

Impact resistant, seamless aluminum housing with cord pendant and wire guard. Upper and lower cord grips for strain relief, junction box pendant mount, and 20' of 16/3 SO cord come standard. Each fixture comes with a remote 1000W Metal Halide 5-Tap Ballast encapsulated in potting compound to reduce noise and heat that is housed in a galvanized powder coated steel weatherproof box.