

CBB SERIES

50W Mercury Vapor Aluminum Bullet with Composite Burial Box

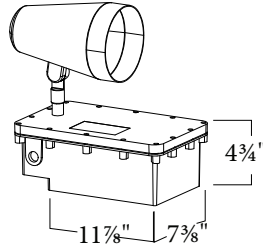

DESIGN

The Composite Burial Boxes were designed for in-grade HID ballast mounting applications. It can be used as a direct mount with a Techlight aluminum bullet or as a remote enclosure. An Anti-Siphon Chamber is provided to ensure no water can enter the main housing.

ORDERING INFORMATION

50W MV BURIAL BOX ONLY ¹	CBB01-MT
50W MV, SM BULLET, UP SHIELD ¹	CBB01-1-1-(A)-1-(B)
50W MV, SM BULLET, PREM TUBE ¹	CBB01-1-17-(A)-1-(B)
50W MV, MED BULLET, UP SHIELD ¹	CBB01-2-4-(A)-2-(B)
50W CTD MV, MED BULLET, UP SHIELD ¹	CBB01-2-4-(A)-3-(B)
50W MV, MED BULLET, PREM TUBE ¹	CBB01-2-17-(A)-2-(B)
50W CTD MV, MED BULLET, PREM TUBE ¹	CBB01-2-17-(A)-3-(B)

(A) Finish

- 1 - OD Green
- 2 - White
- 3 - Bronze
- 4 - Black
- 5 - Special

(B) Voltage

- 1 - 120 Volt
- 2 - 208 Volt
- 3 - 240 Volt
- 4 - 277 Volt

SHIELDS



SMALL UP SHIELD
S2



MEDIUM UP SHIELD
S4



SMALL PREMIUM TUBE
SHIELD
S163-P³



MEDIUM PREMIUM
TUBE SHIELD
S5-P³



SMALL UP SHIELD
WITH BLUE LENS
S36



MEDIUM UP SHIELD
WITH BLUE LENS
S49



SMALL CAST
ALUMINUM UP
SHIELD
S2-CA



MEDIUM CAST
ALUMINUM UP
SHIELD
S4-CA



SMALL HONEYCOMB
LOUVER
S80



MEDIUM
HONEYCOMB LOUVER
S81

TECHNICAL INFORMATION

Made from a compression molded, fiberglass reinforced polyester composite housing. Provided with a 50W Mercury Vapor, multi-tap CWA ballast. Pre-wired at specified voltage using a quick disconnect. Two 3/4" NPT and two 1/2" NPT conduit entries are provided. Dark Bronze finish is standard on the burial box.

Notes: 1-Fixture may be provided with a Metal Halide ballast designed to operate a Mercury Vapor lamp. 2-Premium Shields are designed to allow debris to wash free in an up light position.

CBB SERIES

50W Mercury Vapor Copper Bullet with Composite Burial Box

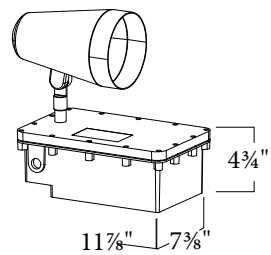

DESIGN

The Composite Burial Boxes were designed for in-grade HID ballast mounting applications. It can be used as a direct mount with a Techlight copper bullet or as a remote enclosure. An Anti-Siphon Chamber is provided to ensure no water can enter the main housing.

ORDERING INFORMATION

50W MV, BURIAL BOX ONLY ¹	CBB01-MT
50W MV, SM BULLET, UP SHIELD ¹	CBB01-4-9- (A)-1- (B)
50W MV, MED BULLET, UP SHIELD ¹	CBB01-3-6- (A)-2- (B)
50W CTD MV, MED BULLET, UP SHIELD ¹	CBB01-3-6- (A)-3- (B)

(A) Finish		(B) Voltage	
1	- OD Green	1	- 120 Volt
2	- White	2	- 208 Volt
3	- Bronze	3	- 240 Volt
4	- Black	4	- 277 Volt
5	- Special		
6	- Natural Copper		

SHIELDS

-  **SMALL COPPER UP SHIELD S66**
-  **SMALL COPPER UP SHIELD WITH BLUE LENS S68**
-  **SMALL HONEYCOMB LOUVER S80**
-  **MEDIUM COPPER UP SHIELD S25**
-  **MEDIUM HONEYCOMB LOUVER S81**

TECHNICAL INFORMATION

Made from a compression molded, fiberglass reinforced polyester composite housing. Provided with a 50W Mercury Vapor, multi-tap CWA ballast. Pre-wired at specified voltage using a quick disconnect. Two 3/4" NPT and two 1/2" NPT conduit entries are provided. Dark Bronze finish is standard on the burial box.

Notes: 1-Fixture may be provided with a Metal Halide ballast designed to operate a Mercury Vapor lamp.

CBB SERIES

100W Mercury Vapor Aluminum Bullet with Composite Burial Box

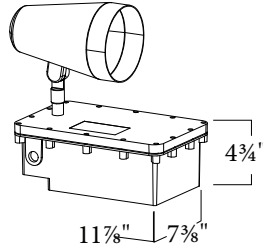

DESIGN

The Composite Burial Boxes were designed for in-grade HID ballast mounting applications. It can be used as a direct mount with a Techlight aluminum bullet or as a remote enclosure. An Anti-Siphon Chamber is provided to ensure no water can enter the main housing.

ORDERING INFORMATION

100W MV BURIAL BOX ONLY ¹	ZCBB02
100W MV, MED BULLET, UP SHIELD ¹	CBB02-1-2-(A)-2-(B)
100W CTD MV, MED BULLET, UP SHIELD ¹	CBB02-1-2-(A)-5-(B)
100W MV, MED BULLET, PREM TUBE ¹	CBB02-1-14-(A)-2-(B)
100W CTD MV, MED BULLET, PREM TUBE ¹	CBB02-1-14-(A)-5-(B)
100W MV, LRG BULLET, UP SHIELD ¹	CBB02-2-4-(A)-4-(B)
100W CTD MV, LRG BULLET, UP SHIELD ¹	CBB02-2-4-(A)-3-(B)
100W MV, LRG BULLET, PREM TUBE ¹	CBB02-2-14-(A)-4-(B)
100W CTD MV, LRG BULLET, PREM TUBE ¹	CBB02-2-14-(A)-3-(B)

(A) Finish

1 - OD Green	1 - 120 Volt
2 - White	2 - 208 Volt
3 - Bronze	3 - 240 Volt
4 - Black	4 - 277 Volt
5 - Special	

(B) Voltage

SHIELDS



MEDIUM UP SHIELD
S4



LARGE UP SHIELD
S9



MEDIUM PREMIUM
TUBE SHIELD
S5-P²



LARGE PREMIUM
TUBE SHIELD
S10-P²



MEDIUM UP SHIELD
WITH BLUE LENS
S49



LARGE TREE TRUNK
SHIELD
S11



MEDIUM CAST
ALUMINUM UP SHIELD
S4-CA



LARGE CAST
ALUMINUM UP
SHIELD
S9-CA



MEDIUM HONEYCOMB
LOUVER
S81



LARGE HONEYCOMB
LOUVER
S82

TECHNICAL INFORMATION

Made from a compression molded, fiberglass reinforced polyester composite housing. Provided with a 100W Mercury Vapor, multi-tap CWA ballast. Pre-wired at specified voltage using a quick disconnect. Two 3/4" NPT and two 1/2" NPT conduit entries are provided. Dark Bronze finish is standard on the burial box.

Notes: 1-Fixture may be provided with a Metal Halide ballast designed to operate a Mercury Vapor lamp. 2-Premium Shields are designed to allow debris to wash free in an up light position.

CBB SERIES

100W Mercury Vapor Copper Bullet with Composite Burial Box

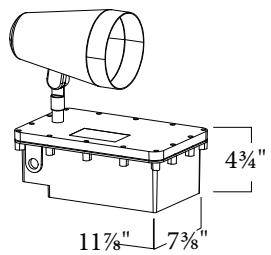

DESIGN





The Composite Burial Boxes were designed for in-grade HID ballast mounting applications. It can be used as a direct mount with a Techlight copper bullet or as a remote enclosure. An Anti-Siphon Chamber is provided to ensure no water can enter the main housing.

ORDERING INFORMATION

100W MV BURIAL BOX ONLY ¹	ZCBB02
100W MV, MED BULLET, UP SHIELD ¹	CBB02-3-6-(A)-2-(B)
100W CTD MV, MED BULLET, UP SHIELD ¹	CBB02-3-6-(A)-5-(B)
100W MV, LRG BULLET, UP SHIELD ¹	CBB02-4-8-(A)-4-(B)
100W CTD MV, LRG BULLET, UP SHIELD ¹	CBB02-4-8-(A)-3-(B)

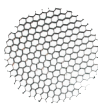
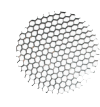
(A) Finish	(B) Voltage
1 - OD Green	1 - 120 Volt
2 - White	2 - 208 Volt
3 - Bronze	3 - 240 Volt
4 - Black	4 - 277 Volt
5 - Special	
6 - Natural Copper	

SHIELDS

- 
MEDIUM COPPER UP SHIELD S25
- 
LARGE HONEYCOMB LOUVER S82
- 
MEDIUM HONEYCOMB LOUVER S81
- 
LARGE COPPER UP SHIELD S27
- 
LARGE COPPER TREE TRUNK SHIELD S69
- 
LARGE COPPER HOUSE SHIELD S59

TECHNICAL INFORMATION

Made from a compression molded, fiberglass reinforced polyester composite housing. Provided with a 100W Mercury Vapor, multi-tap CWA ballast. Pre-wired at specified voltage using a quick disconnect. Two 3/4" NPT and two 1/2" NPT conduit entries are provided. Dark Bronze finish is standard on the burial box.

Notes: 1-Fixture may be provided with a Metal Halide ballast designed to operate a Mercury Vapor lamp.

CBB SERIES

175W Mercury Vapor Aluminum Bullet with Composite Burial Box

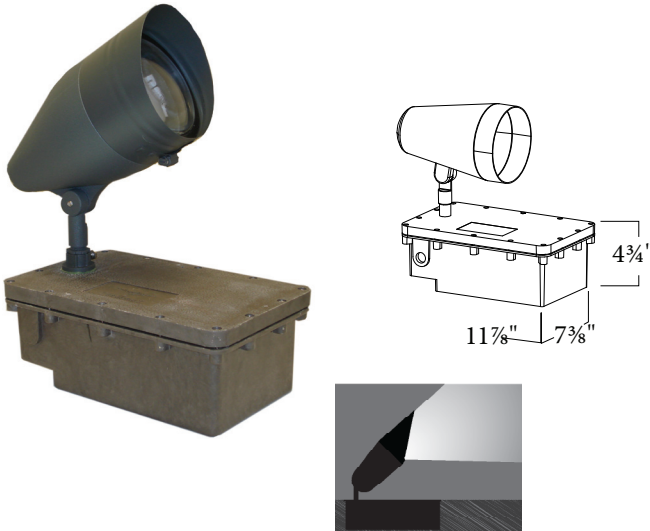

DESIGN

The Composite Burial Boxes were designed for in-grade HID ballast mounting applications. It can be used as a direct mount with a Techlight aluminum bullet or as a remote enclosure. An Anti-Siphon Chamber is provided to ensure no water can enter the main housing.

ORDERING INFORMATION

175W MV BURIAL BOX ONLY ¹	ZCBB03
175W MV, LRG BULLET, UP SHIELD ¹	CBB03-1-2-(A)-2-(B)
175W CTD MV, LRG BULLET, UP SHIELD ¹	CBB03-1-2-(A)-1-(B)
175W MV, LRG BULLET, PREM TUBE ¹	CBB03-1-7-(A)-2-(B)
175W CTD MV, LRG BULLET, PREM TUBE ¹	CBB03-1-7-(A)-1-(B)

(A) Finish	(B) Voltage
1 - OD Green	1 - 120 Volt
2 - White	2 - 208 Volt
3 - Bronze	3 - 240 Volt
4 - Black	4 - 277 Volt
5 - Special	

SHIELDS



TECHNICAL INFORMATION

Made from a compression molded, fiberglass reinforced polyester composite housing. Provided with a 175W Mercury Vapor, multi-tap CWA ballast. Pre-wired at specified voltage using a quick disconnect. Two 3/4" NPT and two 1/2" NPT conduit entries are provided. Dark Bronze finish is standard on the burial box.

Notes: 1-Fixture may be provided with a Metal Halide ballast designed to operate a Mercury Vapor lamp. 2-Premium Shields are designed to

CBB SERIES

175W Mercury Vapor Copper Bullet with Composite Burial Box

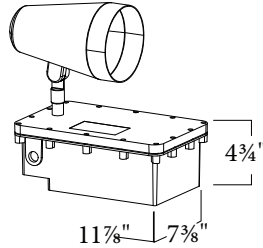

DESIGN

The Composite Burial Boxes were designed for in-grade HID ballast mounting applications. It can be used as a direct mount with a Techlight copper bullet or as a remote enclosure. An Anti-Siphon Chamber is provided to ensure no water can enter the main housing.

ORDERING INFORMATION

175W MV BURIAL BOX ONLY ¹	ZCBB03
175W MV, LRG BULLET, UP SHIELD ¹	CBB03-2-4- (A) -2- (B)
175W CTD MV, LRG BULLET, UP SHIELD ¹	CBB03-2-4- (A) -1- (B)

(A) Finish	(B) Voltage
1 - OD Green	1 - 120 Volt
2 - White	2 - 208 Volt
3 - Bronze	3 - 240 Volt
4 - Black	4 - 277 Volt
5 - Special	
6 - Natural Copper	

SHIELDS



LARGE COPPER UP
SHIELD
S27



LARGE COPPER TREE
TRUNK SHIELD
S69



LARGE COPPER HOUSE
SHIELD
S59

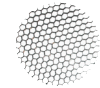

LARGE HONEYCOMB
LOUVER
S82

TECHNICAL INFORMATION

Made from a compression molded, fiberglass reinforced polyester composite housing. Provided with a 175W Mercury Vapor, multi-tap CWA ballast. Pre-wired at specified voltage using a quick disconnect. Two 3/4" NPT and two 1/2" NPT conduit entries are provided. Dark Bronze finish is standard on the burial box.

Notes: 1-Fixture may be provided with a Metal Halide ballast designed to operate a Mercury Vapor lamp.

CBB SERIES

35W Metal Halide Aluminum Bullet with Composite Burial Box

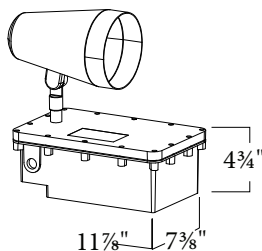

DESIGN

The Composite Burial Boxes were designed for in-grade HID ballast mounting applications. It can be used as a direct mount with a Techlight aluminum bullet or as a remote enclosure. An Anti-Siphon Chamber is provided to ensure no water can enter the main housing.

ORDERING INFORMATION

35W MH BURIAL BOX ONLY	ZCBB04
35W SP MH, SM BULLET, UP SHIELD	CBB04-1-6-(A)-4-(B)
35W FL MH, SM BULLET, UP SHIELD	CBB04-1-6-(A)-3-(B)
35W SP MH, SM BULLET, PREM TUBE	CBB04-1-13-(A)-4-(B)
35W FL MH, SM BULLET, PREM TUBE	CBB04-1-13-(A)-3-(B)
35W SP MH, MED BULLET, UP SHIELD	CBB04-2-2-(A)-1-(B)
35W FL MH, MED BULLET, UP SHIELD	CBB04-2-2-(A)-2-(B)
35W SP MH, MED BULLET, PREM TUBE	CBB04-2-13-(A)-1-(B)
35W FL MH, MED BULLET, PREM TUBE	CBB04-2-13-(A)-2-(B)

(A) Finish	(B) Voltage
1 - OD Green	1 - 120 Volt
2 - White	2 - 208 Volt
3 - Bronze	3 - 240 Volt
4 - Black	4 - 277 Volt
5 - Special	

SHIELDS

	SMALL UP SHIELD S2		MEDIUM UP SHIELD S4
	SMALL PREMIUM TUBE SHIELD S163-P ¹		MEDIUM PREMIUM TUBE SHIELD S5-P ¹
	SMALL UP SHIELD WITH BLUE LENS S36		MEDIUM UP SHIELD WITH BLUE LENS S49
	SMALL CAST ALUMINUM UP SHIELD S2-CA		MEDIUM CAST ALUMINUM UP SHIELD S4-CA
	SMALL HONEYCOMB LOUVER S80		MEDIUM HONEYCOMB LOUVER S81

TECHNICAL INFORMATION

Made from a compression molded, fiberglass reinforced polyester composite housing. Provided with a 35W Pulse Start Metal Halide, multi-tap CWA ballast. Pre-wired at specified voltage using a quick disconnect. Two 3/4" NPT and two 1/2" NPT conduit entries are provided. Dark Bronze finish is standard on the burial box.

Notes: 1-Premium Shields are designed to allow debris to wash free in an up light position.

CBB SERIES

35W Metal Halide Copper Bullet with Composite Burial Box

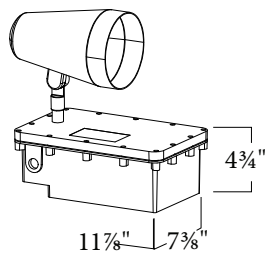

DESIGN

The Composite Burial Boxes were designed for in-grade HID ballast mounting applications. It can be used as a direct mount with a Techlight copper bullet or as a remote enclosure. An Anti-Siphon Chamber is provided to ensure no water can enter the main housing.

ORDERING INFORMATION

35W MH BURIAL BOX ONLY	ZCBB04
35W SP MH, SM BULLET, UP SHIELD	CBB04-4-5-(A)-4-(B)
35W FL MH, SM BULLET, UP SHIELD	CBB04-4-5-(A)-3-(B)
35W SP MH, MED BULLET, UP SHIELD	CBB04-5-4-(A)-2-(B)
35W FL MH, MED BULLET, UP SHIELD	CBB04-5-4-(A)-1-(B)

(A) Finish	(B) Voltage
1 - OD Green	1 - 120 Volt
2 - White	2 - 208 Volt
3 - Bronze	3 - 240 Volt
4 - Black	4 - 277 Volt
5 - Special	
6 - Natural Copper	

SHIELDS

-  **SMALL COPPER UP SHIELD S66**
-  **SMALL COPPER UP SHIELD WITH BLUE LENS S68**
-  **SMALL HONEYCOMB LOUVER S80**
-  **MEDIUM COPPER UP SHIELD S25**
-  **MEDIUM HONEYCOMB LOUVER S81**

TECHNICAL INFORMATION

Made from a compression molded, fiberglass reinforced polyester composite housing. Provided with a 35W Pulse Start Metal Halide, multi-tap CWA ballast. Pre-wired at specified voltage using a quick disconnect. Two 3/4" NPT and two 1/2" NPT conduit entries are provided. Dark Bronze finish is standard on the burial box.

CBB SERIES

70W Metal Halide Aluminum Bullet with Composite Burial Box

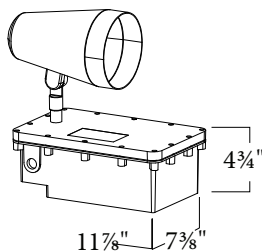

DESIGN

The Composite Burial Boxes were designed for in-grade HID ballast mounting applications. It can be used as a direct mount with a Techlight aluminum bullet or as a remote enclosure. An Anti-Siphon Chamber is provided to ensure no water can enter the main housing.

ORDERING INFORMATION

70W MH BURIAL BOX ONLY	ZCBB05
70W SP MH, MED BULLET, UP SHIELD	CBB05-1-2-(A)-2-(B)
70W FL MH, MED BULLET, UP SHIELD	CBB05-1-2-(A)-1-(B)
70W SP MH, MED BULLET, PREM TUBE	CBB05-1-14-(A)-2-(B)
70W FL MH, MED BULLET, PREM TUBE	CBB05-1-14-(A)-1-(B)
70W FL MH, LRG BULLET, UP SHIELD	CBB05-2-4-(A)-9-(B)
70W FL MH, LRG BULLET, PREM TUBE	CBB05-2-14-(A)-9-(B)

(A) Finish	(B) Voltage
1 - OD Green	1 - 120 Volt
2 - White	2 - 208 Volt
3 - Bronze	3 - 240 Volt
4 - Black	4 - 277 Volt
5 - Special	

SHIELDS

	MEDIUM UP SHIELD S4		LARGE UP SHIELD S9
	MEDIUM PREMIUM TUBE SHIELD S5-P ¹		LARGE PREMIUM TUBE SHIELD S10-P ¹
	MEDIUM UP SHIELD WITH BLUE LENS S49		LARGE TREE TRUNK SHIELD S11
	MEDIUM CAST ALUMINUM UP SHIELD S4-CA		LARGE CAST ALUMINUM UP SHIELD S9-CA
	MEDIUM HONEYCOMB LOUVER S81		LARGE HONEYCOMB LOUVER S82

TECHNICAL INFORMATION

Made from a compression molded, fiberglass reinforced polyester composite housing. Provided with a 70W Pulse Start Metal Halide, multi-tap CWA ballast. Pre-wired at specified voltage using a quick disconnect. Two 3/4" NPT and two 1/2" NPT conduit entries are provided. Dark Bronze finish is standard on the burial box.

Notes: 1-Premium Shields are designed to allow debris to wash free in an up light position.

CBB SERIES

70W Metal Halide Copper Bullet with Composite Burial Box

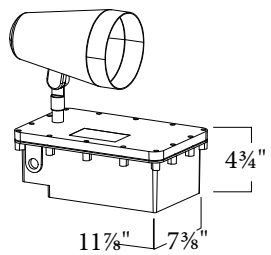

DESIGN





The Composite Burial Boxes were designed for in-grade HID ballast mounting applications. It can be used as a direct mount with a Techlight copper bullet or as a remote enclosure. An Anti-Siphon Chamber is provided to ensure no water can enter the main housing.

ORDERING INFORMATION

70W MH BURIAL BOX ONLY	ZCBB05
70W SP MH, MED BULLET, UP SHIELD	CBB05-3-6-(A)-2-(B)
70W FL MH, MED BULLET, UP SHEILD	CBB05-3-6-(A)-1-(B)
70W FL, LRG BULLET, UP SHIELD	CBB05-4-8-(A)-9-(B)

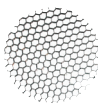
(A) Finish		(B) Voltage	
1	- OD Green	1	- 120 Volt
2	- White	2	- 208 Volt
3	- Bronze	3	- 240 Volt
4	- Black	4	- 277 Volt
5	- Special		
6	- Natural Copper		

SHIELDS

- 
MEDIUM COPPER UP SHIELD S25
- 
LARGE HONEYCOMB LOUVER S82
- 
MEDIUM HONEYCOMB LOUVER S81
- 
LARGE COPPER UP SHIELD S27
- 
LARGE COPPER TREE TRUNK SHIELD S69
- 
LARGE COPPER HOUSE SHIELD S59

TECHNICAL INFORMATION

Made from a compression molded, fiberglass reinforced polyester composite housing. Provided with a 70W Pulse Start Metal Halide, multi-tap CWA ballast. Pre-wired at specified voltage using a quick disconnect. Two 3/4" NPT and two 1/2" NPT conduit entries are provided. Dark Bronze finish is standard on the burial box.

CBB SERIES

100W Metal Halide Aluminum Bullet with Composite Burial Box

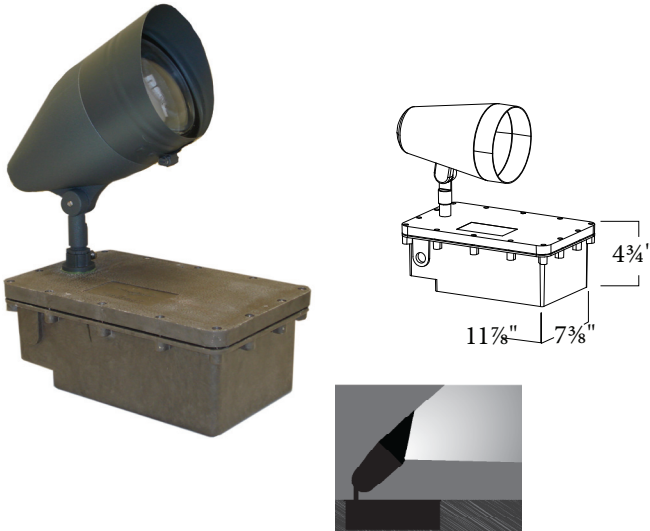

DESIGN

The Composite Burial Boxes were designed for in-grade HID ballast mounting applications. It can be used as a direct mount with a Techlight aluminum bullet or as a remote enclosure. An Anti-Siphon Chamber is provided to ensure no water can enter the main housing.

ORDERING INFORMATION

100W MH BURIAL BOX ONLY	ZCBB06
100W FL MH, LRG BULLET, UP SHIELD	CBB06-1-2-(A)-5-(B)
100W FL MH, LRG BULLET, PREM TUBE	CBB06-1-8-(A)-5-(B)

(A) Finish		(B) Voltage	
1	- OD Green	1	- 120 Volt
2	- White	2	- 208 Volt
3	- Bronze	3	- 240 Volt
4	- Black	4	- 277 Volt
5	- Special		

SHIELDS



TECHNICAL INFORMATION

Made from a compression molded, fiberglass reinforced polyester composite housing. Provided with a 100W Pulse Start Metal Halide, multi-tap CWA ballast. Pre-wired at specified voltage using a quick disconnect. Two 3/4" NPT and two 1/2" NPT conduit entries are provided. Dark Bronze finish is standard on the burial box.

Notes: 1-Premium Shields are designed to allow debris to wash free in an up light position.

CBB SERIES

100W Metal Halide Copper Bullet with Composite Burial Box

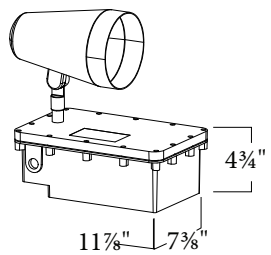

DESIGN

The Composite Burial Boxes were designed for in-grade HID ballast mounting applications. It can be used as a direct mount with a Techlight copper bullet or as a remote enclosure. An Anti-Siphon Chamber is provided to ensure no water can enter the main housing.

ORDERING INFORMATION

100W MH BURIAL BOX ONLY	ZCBB06
100W FL MH, LRG BULLET, UP SHIELD	CBB06-2-4-(A)-5-(B)

(A) Finish	(B) Voltage
1 - OD Green	1 - 120 Volt
2 - White	2 - 208 Volt
3 - Bronze	3 - 240 Volt
4 - Black	4 - 277 Volt
5 - Special	
6 - Natural Copper	

SHIELDS

-  **LARGE COPPER UP SHIELD S27**
-  **LARGE COPPER TREE TRUNK SHIELD S69**
-  **LARGE COPPER HOUSE SHIELD S59**
-  **LARGE HONEYCOMB LOUVER S82**

TECHNICAL INFORMATION

Made from a compression molded, fiberglass reinforced polyester composite housing. Provided with a 100W Pulse Start Metal Halide, multi-tap CWA ballast. Pre-wired at specified voltage using a quick disconnect. Two 3/4" NPT and two 1/2" NPT conduit entries are provided. Dark Bronze finish is standard on the burial box.

CBB SERIES

175W Metal Halide Aluminum Bullet with Composite Burial Box

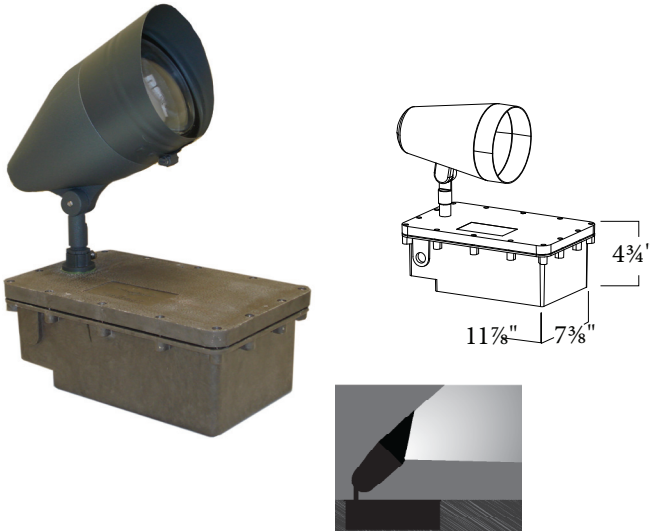

DESIGN

The Composite Burial Boxes were designed for in-grade HID ballast mounting applications. It can be used as a direct mount with a Techlight aluminum bullet or as a remote enclosure. An Anti-Siphon Chamber is provided to ensure no water can enter the main housing.

ORDERING INFORMATION

175W MH BURIAL BOX ONLY	ZCBB07
175W FL MH, LRG BULLET, UP SHIELD	CBB07-1-2-(A)-3-(B)
175W FL MH, LRG BULLET, PREM TUBE	CBB07-1-7-(A)-3-(B)

(A) Finish		(B) Voltage	
1	- OD Green	1	- 120 Volt
2	- White	2	- 208 Volt
3	- Bronze	3	- 240 Volt
4	- Black	4	- 277 Volt
5	- Special		

SHIELDS



TECHNICAL INFORMATION

Made from a compression molded, fiberglass reinforced polyester composite housing. Provided with a 175W Pulse Start Metal Halide, multi-tap CWA ballast. Pre-wired at specified voltage using a quick disconnect. Two 3/4" NPT and two 1/2" NPT conduit entries are provided. Dark Bronze finish is standard on the burial box.

Notes: 1-Premium Shields are designed to allow debris to wash free in an up light position.

CBB SERIES

175W Metal Halide Copper Bullet with Composite Burial Box

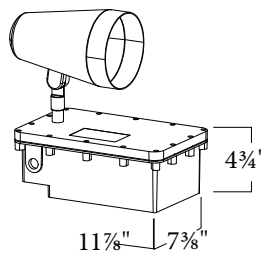

DESIGN

The Composite Burial Boxes were designed for in-grade HID ballast mounting applications. It can be used as a direct mount with a Techlight copper bullet or as a remote enclosure. An Anti-Siphon Chamber is provided to ensure no water can enter the main housing.

ORDERING INFORMATION

175W MH BURIAL BOX ONLY ZCBB07

175W FL MH, LRG BULLET, UP SHIELD CBB07-1-4-(A)-3-(B)

(A) Finish		(B) Voltage	
1	- OD Green	1	- 120 Volt
2	- White	2	- 208 Volt
3	- Bronze	3	- 240 Volt
4	- Black	4	- 277 Volt
5	- Special		
6	- Natural Copper		

SHIELDS

- 
LARGE COPPER UP SHIELD
S27
- 
LARGE COPPER TREE TRUNK SHIELD
S69
- 
LARGE COPPER HOUSE SHIELD
S59
- 
LARGE HONEYCOMB LOUVER
S82

TECHNICAL INFORMATION

Made from a compression molded, fiberglass reinforced polyester composite housing. Provided with a 175W Pulse Start Metal Halide, multi-tap CWA ballast. Pre-wired at specified voltage using a quick disconnect. Two 3/4" NPT and two 1/2" NPT conduit entries are provided. Dark Bronze finish is standard on the burial box.